

PRATIKO[®]

NEW

CE



PVC SLOTTED GRID - GRILLE A FENTE EN PVC - REJILLA CON FISURA EN PVC



FIRST[®]
CORPORATION
Srl.

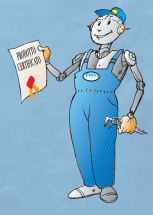

PVC SLOTTED GRID - GRILLE A FENTE EN PVC - REJILLA CON FISURA EN PVC

SERIE 100

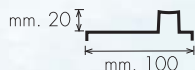
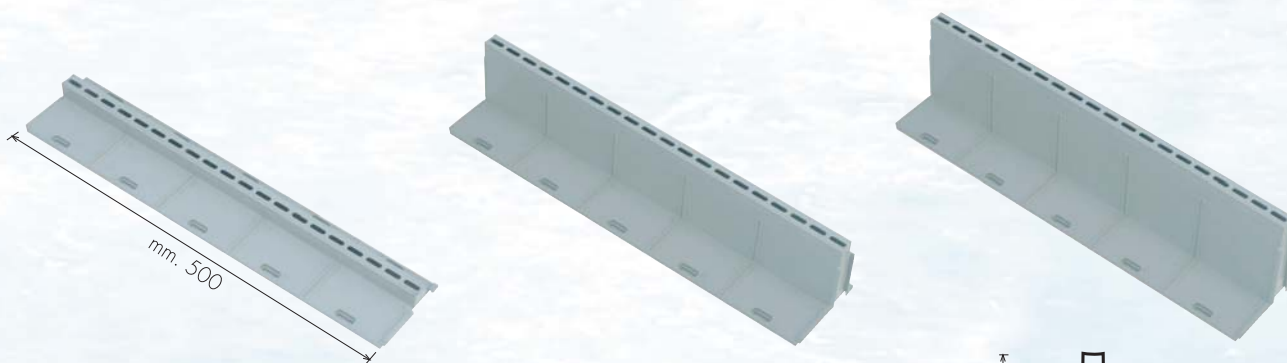

PCF 1020 G
PVC slotted grid
Grille à fente en PVC
Rejilla con fisura en PVC

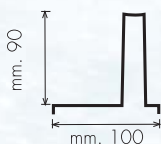

PCF 1090 G
PVC slotted grid
Grille à fente en PVC
Rejilla con fisura en PVC

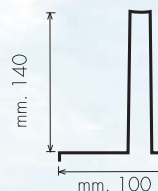

PCF 1014 G
PVC slotted grid
Grille à fente en PVC
Rejilla con fisura en PVC

Code Code Codigo	Raw material Matière première Materia prima	Water evacuation area Section de décharge d'eau Sección paso agua cm ²	Dimension Dimensión Dimensión	Colour Couleur Color
PCF 1020 G	PVC	22,45	mm. 100 x 500 - h. mm. 20	Grey-Gris-Gris
PCF 1090 G	PVC	22,45	mm. 100 x 500 - h. mm. 90	Grey-Gris-Gris
PCF 1014 G	PVC	22,45	mm. 100 x 500 - h. mm. 140	Grey-Gris-Gris



PVC GRILLED CHANNELS - CANIVEAUX A GRILLES EN PVC - CANALETA CON REJILLA EN PVC

SERIE 100

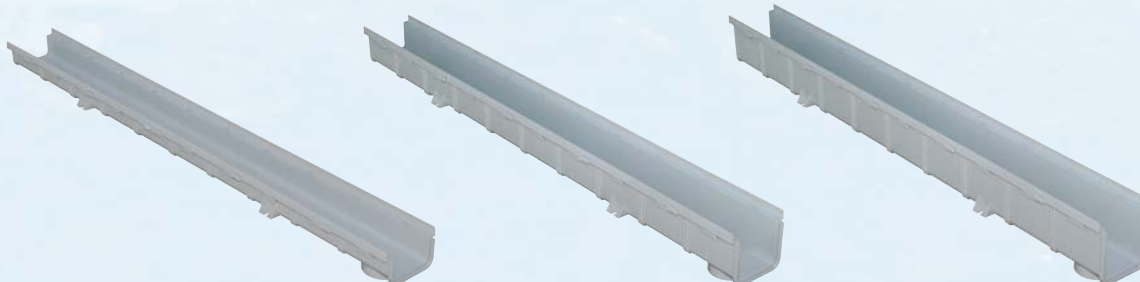

PVC SLOTTED GRID - GRILLE A FENTE EN PVC - REJILLA CON FISURA EN PVC

SERIE 130

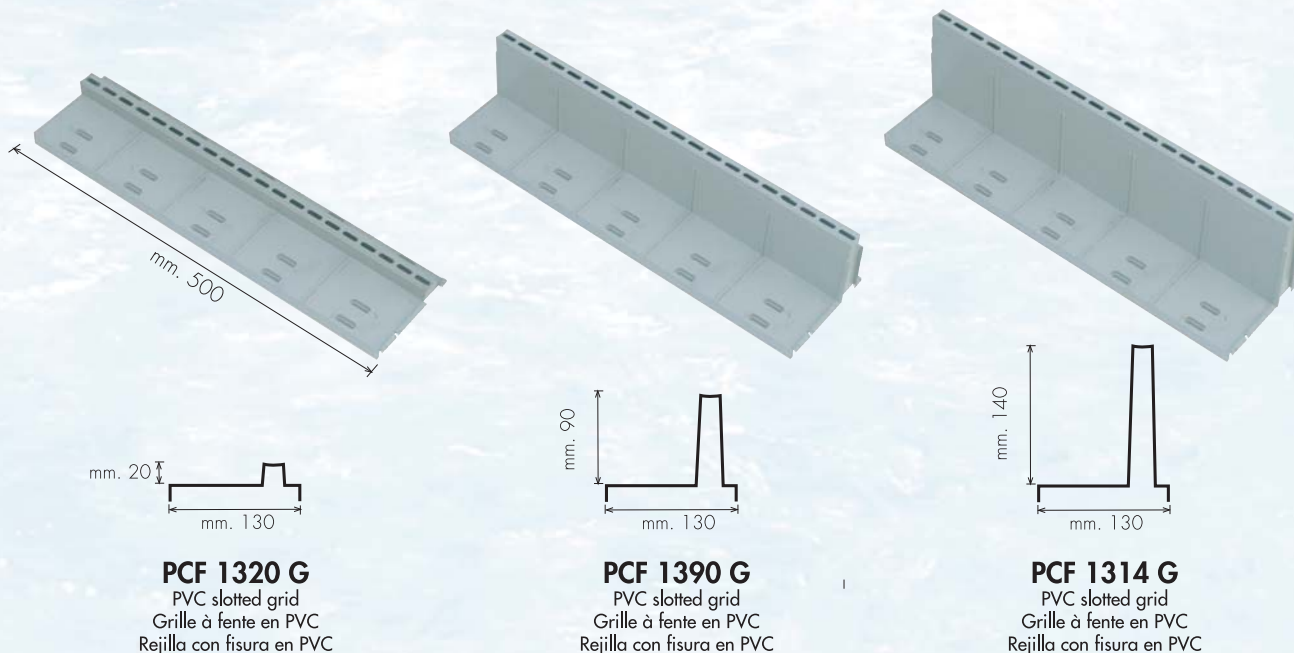

PCF 1320 G

PVC slotted grid
Grille à fente en PVC
Rejilla con fisura en PVC

PCF 1390 G

PVC slotted grid
Grille à fente en PVC
Rejilla con fisura en PVC

PCF 1314 G

PVC slotted grid
Grille à fente en PVC
Rejilla con fisura en PVC

Code Code Codigo	Raw material Matière première Materia prima	Water evacuation area Section de décharge d'eau Sección paso agua cm ²	Dimension Dimensión Dimensión	Colour Couleur Color
PCF 1320 G	PVC	22,45	mm. 130 x 500 - h. mm. 20	Grey-Gris-Gris
PCF 1390 G	PVC	22,45	mm. 130 x 500 - h. mm. 90	Grey-Gris-Gris
PCF 1314 G	PVC	22,45	mm. 130 x 500 - h. mm. 140	Grey-Gris-Gris



PVC GRILLED CHANNELS - CANIVEAUX A GRILLES EN PVC - CANALETA CON REJILLA EN PVC

SERIE 130

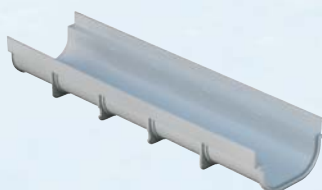

TECHNICAL FEATURES-CARACTERISTIQUES TECHNIQUES-CARACTERISTICAS TECNICAS

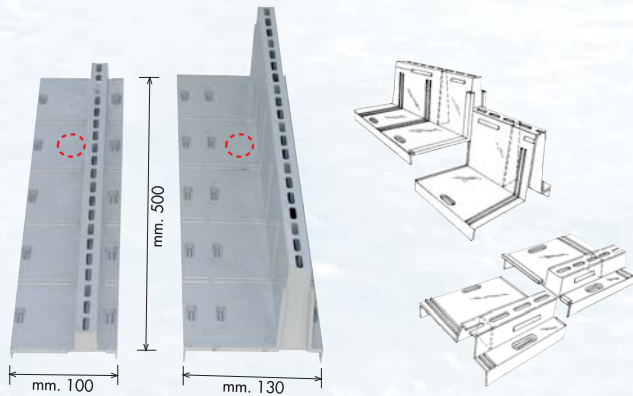

✳ The PVC slotted grid is available in 3 different heights 20, 90 and 140 mm. to match the features of different flooring.

✳ La grille à fente en PVC est disponible en trois hauteurs différentes: 20, 90 et 140 mm. pour mieux s'adapter à tout type de carrelage.

✳ La rejilla con fisura en PVC está disponible en tres alturas: 20, 90 y 140 mm para de esta forma adaptarse a las diferentes alturas del pavimento.

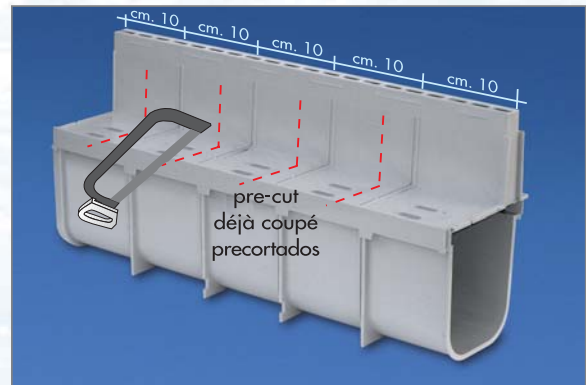

✳ Onto the PVC slotted grid it is also possible to install 40 mm Ø discharges.

✳ Sur la grille à fente en PVC il est possible d'installer des sorties (décharges) de 40 mm. de diamètre.

✳ En rejilla con fisura en PVC tenemos la posibilidad de inserir descargas de 40 mm. de diametro

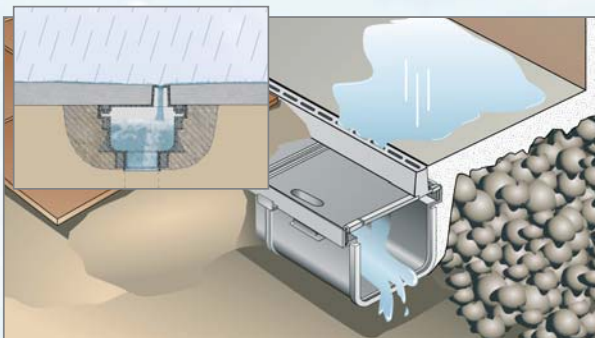

Example of installation of the 20 mm height pvc slotted grid.
Exemple d'application du modèle bas (h 20 mm.)
Ejemplo de aplicación del modelo bajo (h 20 mm.)

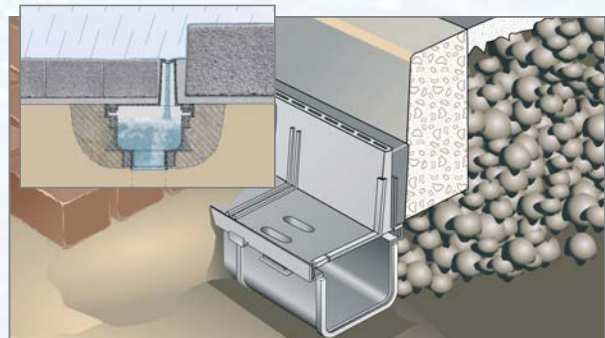

Example of installation of the 90 and 140 mm height pvc slotted grid.
Exemple d'application du modèle moyen/haut (h 90/140 mm.)
Ejemplo de aplicación del modelo medio y alto (h 90/140 mm.)

www.flografiaabacchetta.it - 06/10

✳ The product has the same modularity features of the PRATIKO drainage channels so that the single elements can be combined together reaching different lengths, but always multiple of 100 mm. The pre-cut points are clearly shown on the product; the cuts can be made with a common hacksaw.

✳ Cette grille présente les mêmes caractéristiques de modularité que les caniveaux PRATIKO. Les longueurs, par multiple de 100 mm, permettent un alignement parfait. La coupe est facilitée par des lignes de pré découpage.

✳ El artículo tiene las mismas características a múltiplos de modularidad que nuestra canaleta PRATIKO, que permite acoplar elementos y de esta forma lograr las medidas necesarias a múltiplos de 100 mm. En el producto está indicado el punto de corte y de esta forma poder sellarlo conjuntamente.



Località Isola Grande • 17041 ALTARE (SV) • ITALY TEL. +39 019 58511 • FAX +39 019 58286 e-mail: infofirst@firstcor.com • www.firstcor.com

